





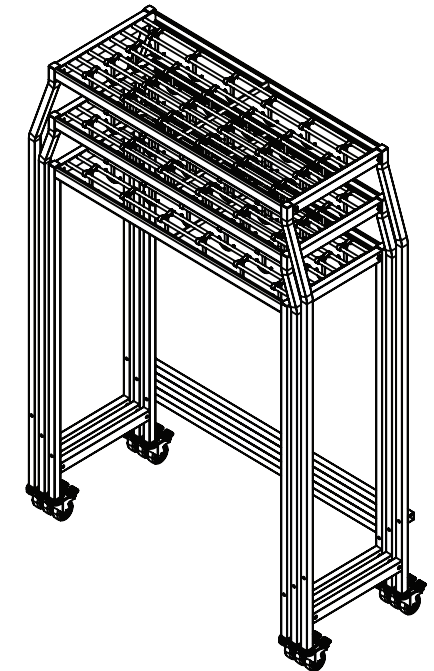

-  1. Socket cap screw M8 x 25
-  2. Fastening nut M8
-  3. Socket cap screw M8 x 70
-  4. Spacer
-  5. Nut / cap nut M8
-  6. Insert



- Rack must be lifted upright. The castors must be off the floor during the lift.
- After installation castors must be turned to the position showed in the picture and they must be locked
- Instructions for the maintenance and use can be found on Monena's website on a product-by-product basis.

Please ensure that this information is passed on to end user.